

700 meters Data _____

Start elev_{19.0} _____ Start Wind _____ Fsdia_{4.8} _____ +EE, Rsdia_{1.0} _____

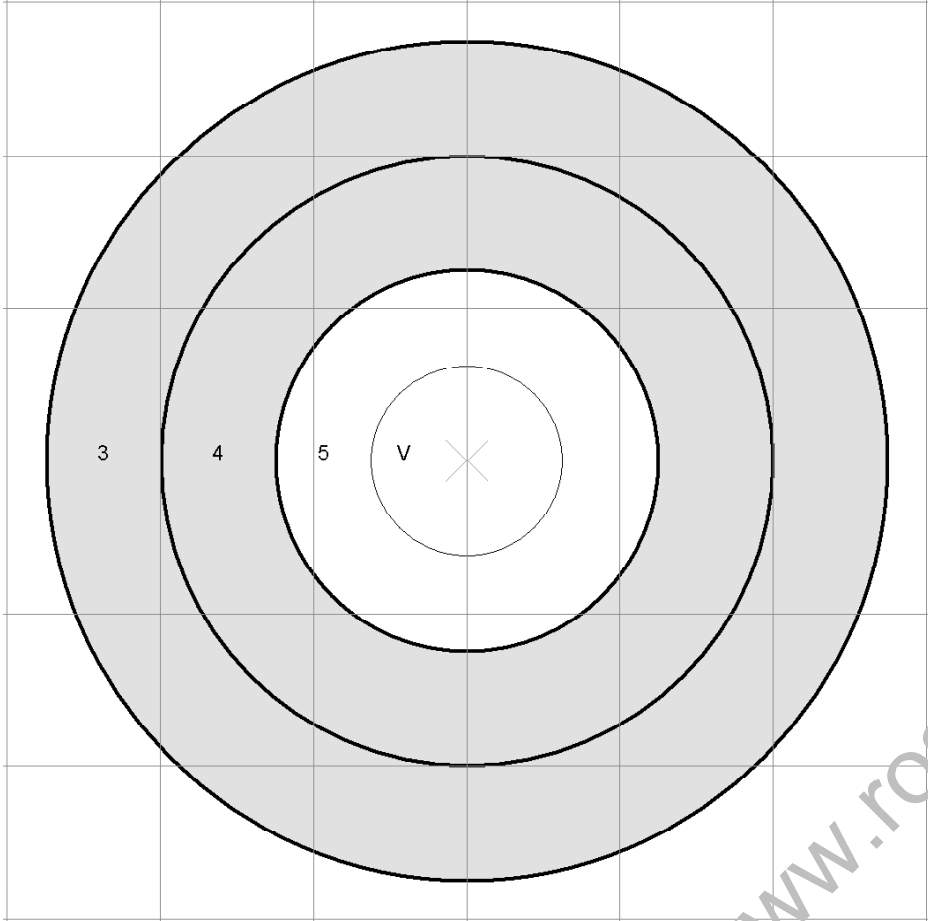

Finish elev _____ Finish wind _____

	↑	↔	wnd	rslt
ST				
A				
B				
1				
2				
3				
4				
5				
6				
7				
8				
9				
10				

700 meters

Start elev_{19.0} _____ Start Wind _____ Fsdia_{4.8} _____ +EE, Rsdia_{1.0} _____

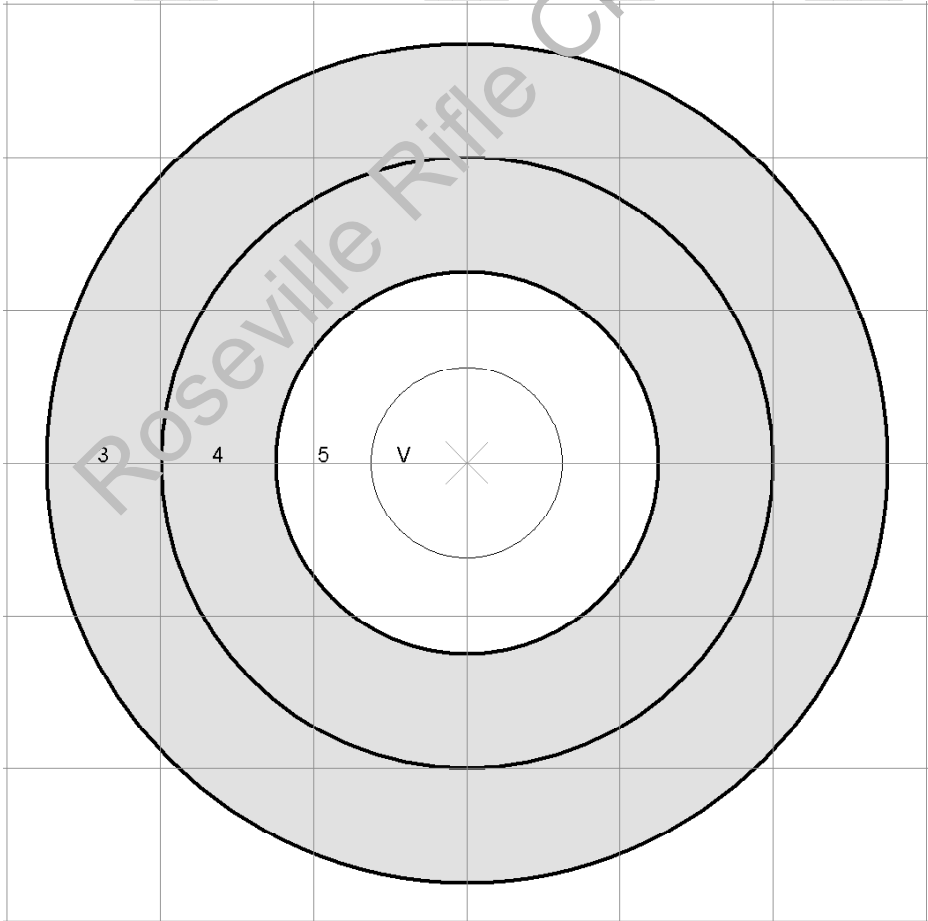

Finish elev _____ Finish wind _____

	↑	↔	wnd	rslt
ST				
A				
B				
1				
2				
3				
4				
5				
6				
7				
8				
9				
10				